



PREVOST.
THE ULTIMATE EXPERIENCE

PrevoSt Service & Maintenance

Motorhome Expo 2018

Tommy Nolet, Manager Eastern Customer Support Team

Agenda



1. Where to Start ?
2. Where to find your VIN (Vehicle Identification Number)
3. How to read a Prevost VIN
4. How to access the Prevost Technical Publication site
5. Find your Maintenance Schedule
6. Quick look at the Prevost Apps
7. Q & A

Where to Start ?

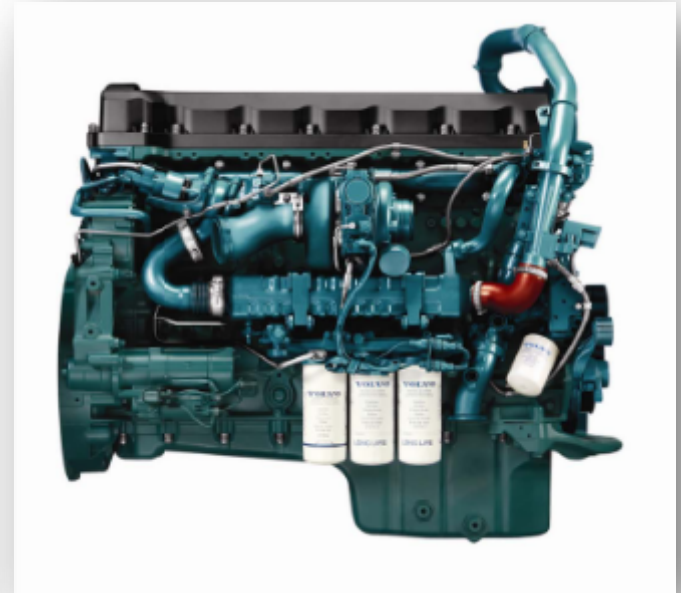
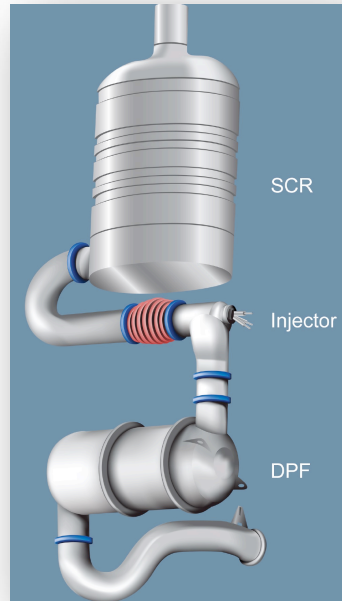

Where to find your VIN

- The complete VIN (Vehicle Identification Number) can be found:
 - On the Driver Left side windshield Post or through the Passenger side Windshield attached to the defroster vent, depending on the year model.
 - On the LH console next to the driver or behind the Driver's seat, depending of year model

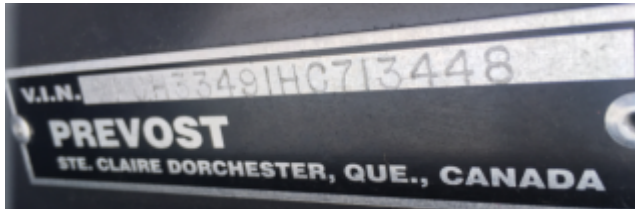

How to read a Prevest

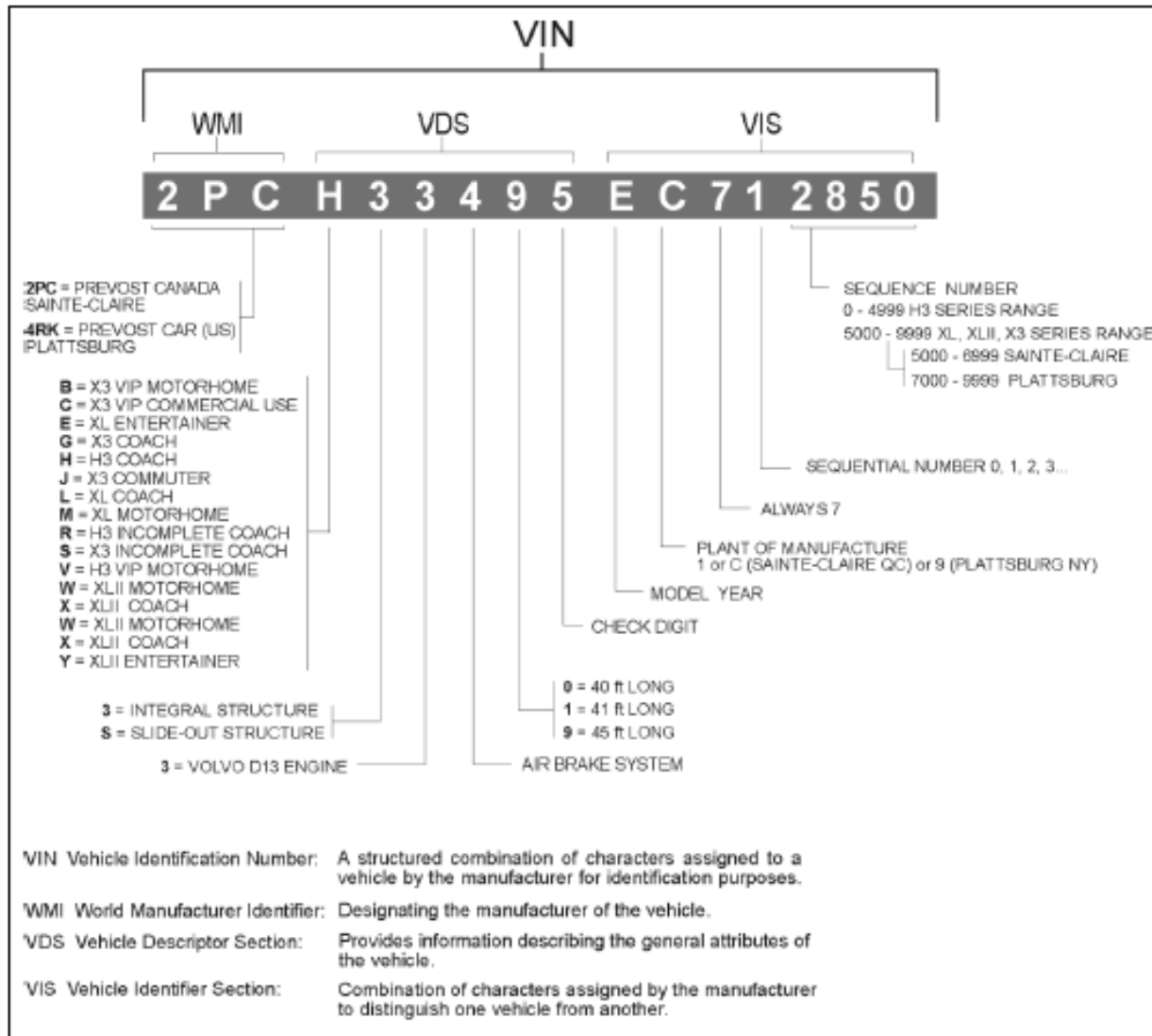

FIGURE 10: VEHICLE IDENTIFICATION NUMBER

00057_5

How to read a Prevest VIN

TABLE 1: CHARACTER IDENTIFYING THE VEHICLE MODEL TYPE (4th POSITION IN THE VIN)

B = X3 VIP MOTORHOME
C = X3 VIP COMMERCIAL USE
E = XL ENTERTAINER
G = X3 COACH
H = H3 COACH
J = X3 COMMUTER
L = XL COACH
M = XL MOTORHOME
R = H3 INCOMPLETE COACH
S = X3 INCOMPLETE COACH
V = H3 VIP MOTORHOME
W = XLII MOTORHOME
X = XLII COACH
W = XLII MOTORHOME
X = XLII COACH
Y = XLII ENTERTAINER

TABLE 2: CHARACTER IDENTIFYING THE VEHICLE MODEL YEAR (10th POSITION IN THE VIN)

Year	Code	Year	Code	Year	Code	Year	Code
1980	A	1990	L	2000	Y	2010	A
1981	B	1991	M	2001	1	2011	B
1982	C	1992	N	2002	2	2012	C
1983	D	1993	P	2003	3	2013	D
1984	E	1994	R	2004	4	2014	E
1985	F	1995	S	2005	5	2015	F
1986	G	1996	T	2006	6	2016	G
1987	H	1997	V	2007	7	2017	H
1988	J	1998	W	2008	8	2018	J
1989	K	1999	X	2009	9	2019	K

How to read a Prevest VIN



PREVOST

ENREGISTRÉ - REGISTERED
ISO 9001 & ISO 14001

**MAINTENANCE
INFORMATION**

Mi00-08



PREVOST

DATE : March 2000	SECTION : 00 - General
SUBJECT : UNDERSTANDING THE VIN	

DESCRIPTION

With the addition of the XLII coach and bus shell, some code letters in the vehicle identification number (VIN) have been added. The following information explains the contents and structure of the VIN:

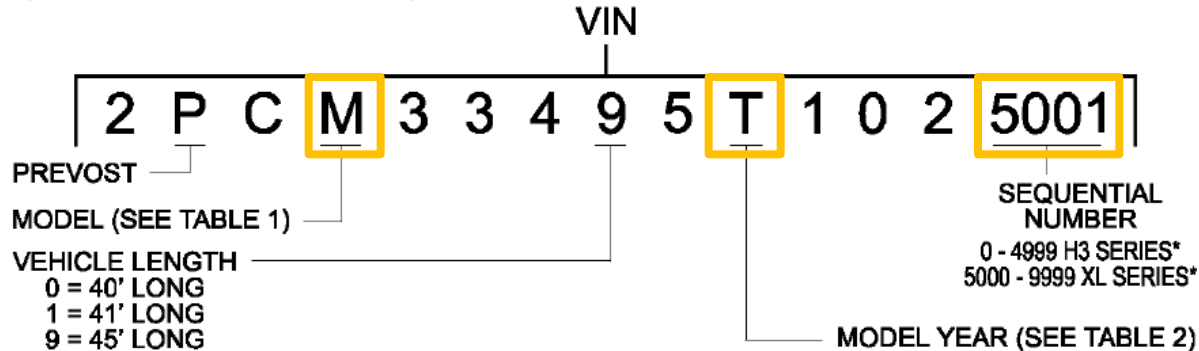

(*) For vehicle model years 1996 (T) and up only.

VIN Vehicle Identification Number: A structured combination of characters assigned to a vehicle by the manufacturer for identification purposes.

Find your Maintenance Schedule

Example of a 2018 year model with a Volvo D13 Engine

5 LUBRICATION AND SERVICING SCHEDULE - MOTORHOMES

LUBRICATION AND SERVICING SCHEDULE			ITEM	EVERY (months)	LUBRICANT / FLUID ⁸
H3-45 VIP & X3-45 VIP MOTORHOMES (Private Use)					
A red stripe in the left margin of the schedule highlights the latest changes					
GENERAL					
All flexible hoses – inspect				12	
H3 VIP Series only: Main power compartment fan air filter – inspect				12	
01 ENGINE					
Engine oil and filters – change			24	12	A B C
Air cleaner – change filter element			30	24	
Engine mounted alternators & house alternator(s) – change drive belts and intermediary drive belts				24	
Coolant pump drive belt – change				24	
Valves and injectors – initial adjustment: after 2 500 hours or 36 months whichever occurs first			2 4	36	
Valves and injectors – check and adjust: every 5 000 hours or 72 months whichever occurs first			2 4	72	
03 FUEL					
Primary fuel filter & secondary fuel filter – change at every engine oil change			21, 22		

Find your Maintenance Schedule

Example of a 2018 year model with a Volvo D13 Engine

5 LUBRICATION AND SERVICING SCHEDULE - MOTORHOMES

6 FLUIDS AND LUBRICANTS SPECIFICATIONS					
Coaches Schedule		FLUIDS & LUBRICANTS TABLE		Motorhome Schedule	
REF	SYSTEMS	REF	DESCRIPTIONS / SPECIFICATIONS		
A	Engine Oil	Extended drains A	SAE Viscosity Grade: 10W-30 ¹ Filled with "Volvo Premium Motor Oil VDS-4.5"		
B	Engine Oil	Extended drains B	SAE Viscosity Grade: 10W-30 ¹ Filled with other Volvo Approved VDS-4.5 oils		
C	Engine Oil	Regular drains	SAE Viscosity Grade: 10W-30 ¹ Filled with "Volvo Premium Motor Oil VDS-4"		
D	Power Steering fluid	Automatic Transmission Fluid (ATF), Dexron-IIIIF, G, H or Dexron-VI Refer to Bosch List of lubricants TE-ML 09 for further details			
E	Engine Coolant	Texaco or Chevron Extended Life Coolant (ELC) 50% antifreeze/water solution is normally used			

How to access Prevest Technical Publication

<https://www.prevestcar.com/>

Contact Us Member/Client Login Français

PREVOST

TECHNICAL PUBLICATIONS

Home | Wiring Diagrams | Pneumatic Diagrams | Technical Manuals | Service Bulletins | Supplier Publications | Parts Manuals

> VISIT PREVOST MAIN WEBSITE

> REFERENCE GUIDES

> CHECK OUT PREVOST TOOLS

Welcome to the Prevest Technical Publications Web Site!

This site offers you the opportunity to access Prevest and Volvo Bus related vehicle information such as service bulletins/manuals, wiring schematics, operator manuals, maintenance information, and more.

Latest Additions

WB17-16 Service Bulletins
Model: X3-45 | Year(s): 2011 - 2014

C15 & C58 CONNECTOR BYPASS
Updated: February 2, 2018

SR17-85 Service Bulletins
Model: 9700 | Year(s): 2016 - 2018

Quick look at the Prevest Apps



Full Name:
Prevest tools

Markets:
+ Americas

Target user:
+ Customer



Description:
+ Find a multitude of service, warranty or parts info and support for your North American Prevest or Volvo coach



Full Name:
Prevest Service Locator – Prevest Network

Markets:
+ Americas

Target user:
+ Customer



Description:
+ Find your nearest Prevest Service Center or Prevest Certified Service Provider in North America, based upon your current location



Full Name:
Prevest Delivery Track

Markets:
+ Americas

Target user:
+ Logistics



Description:
+ Take confirmation pictures of your deliveries, paperwork or any incident. Your pictures are geo-tagged and dated



Full Name:
Prevest Code

Markets:
+ Americas

Target user:
+ Logistics



Description:
+ Take confirmation pictures of your deliveries, paperwork or any incident. Your pictures are geo-tagged and dated

Quick look at the Prevest Apps

Prevest Tools App



Prevest Service Locator

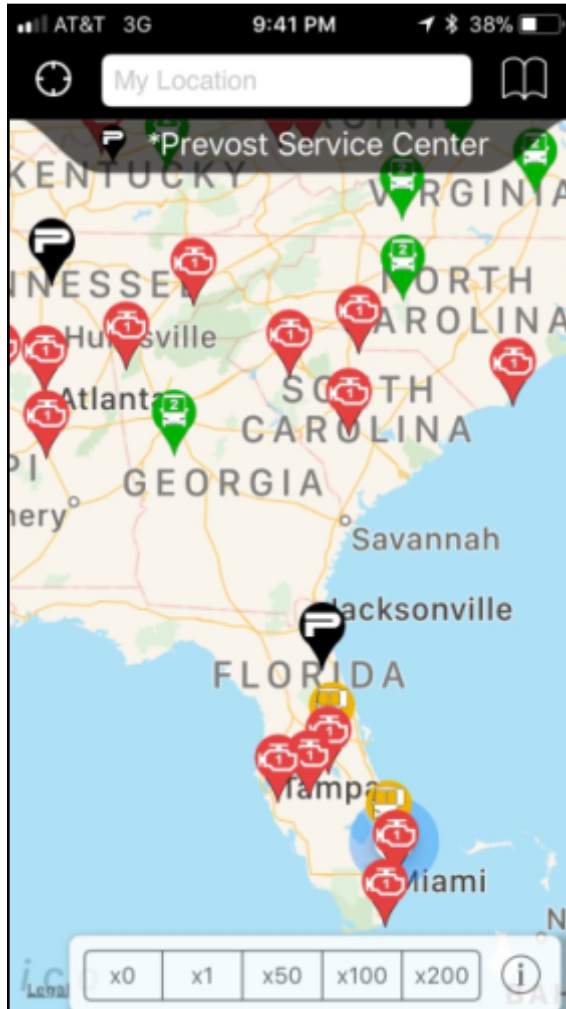

Prevest Code

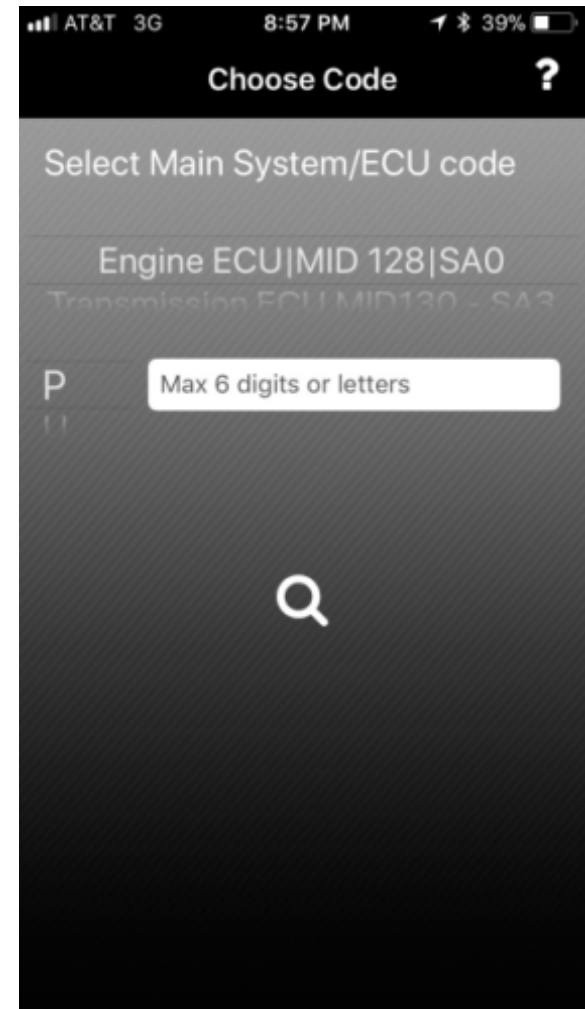

Quick look at the Prevest Apps

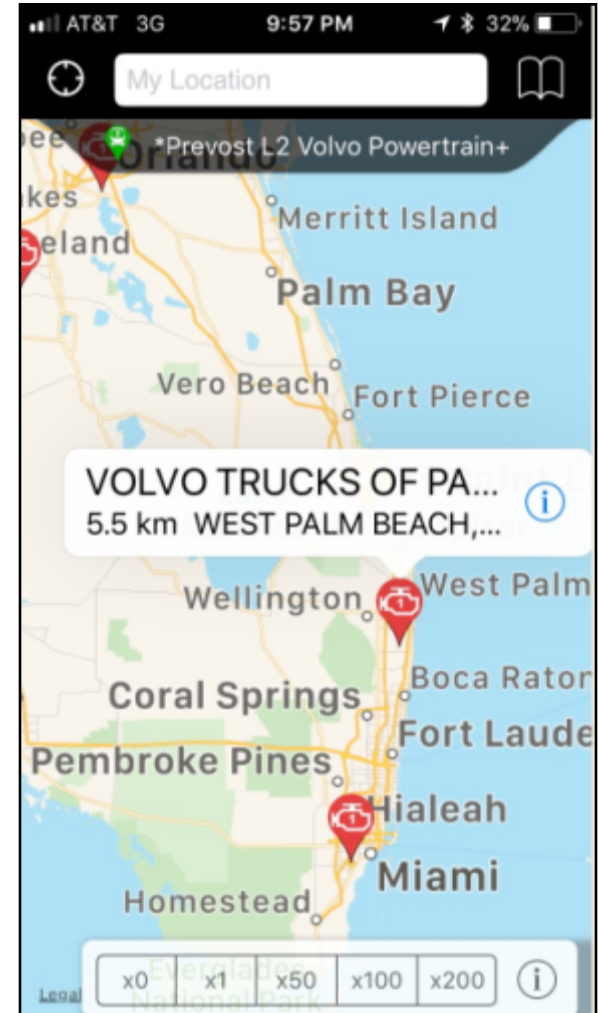
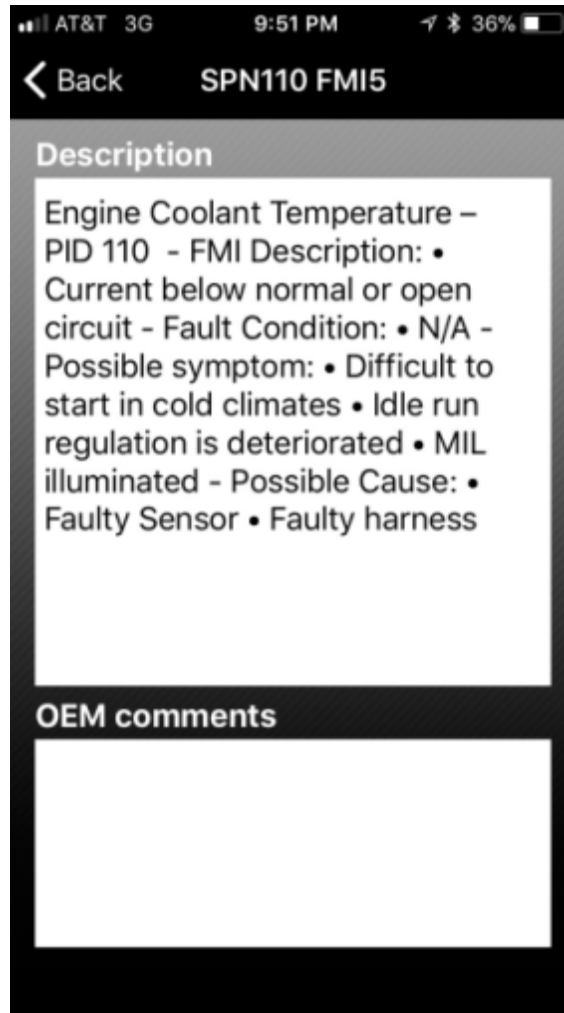
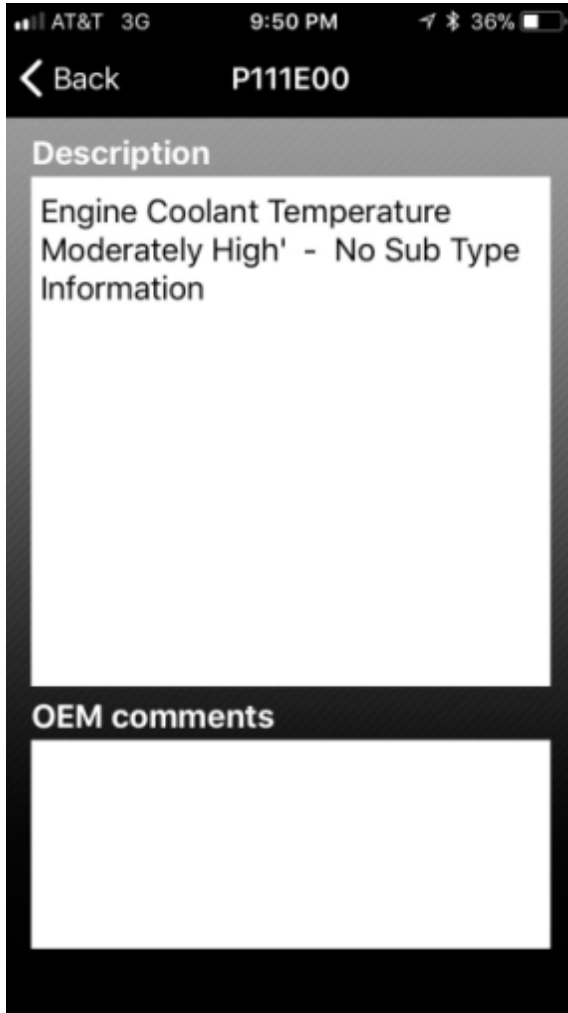



**THE ULTIMATE
EXPERIENCE**

PREVOST.